

# Data Sheet



Article number: 604132048085

Description: Taper bored timing belt pulley  
HTD 48 8M 85 TL 2517

## Measures

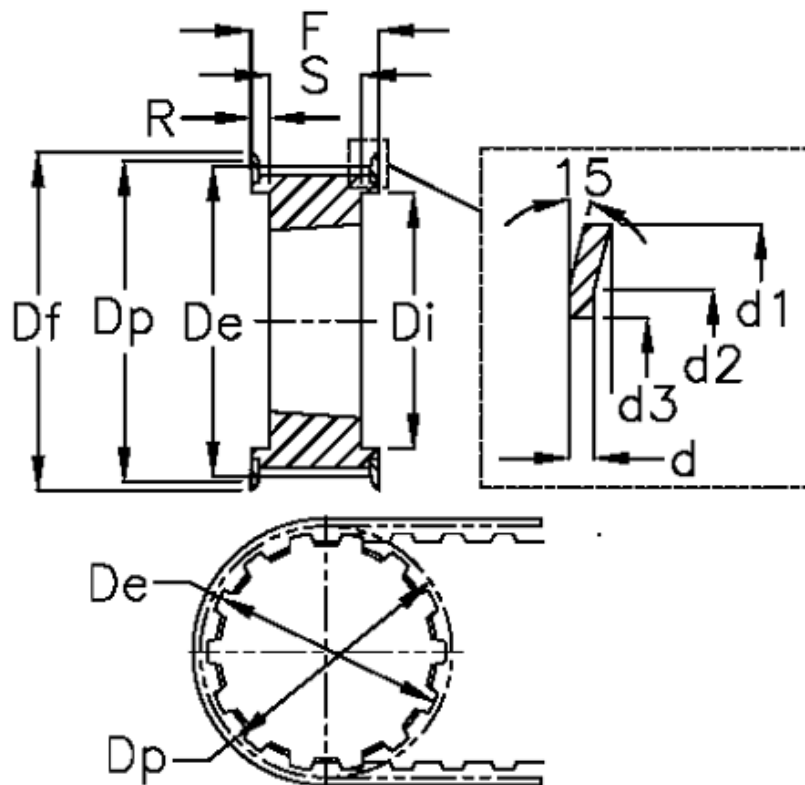

d = 1.5	F = 95	Weight = 2.66
d1 = 128	Flange type = F40	Width = 85
d2 = 124	For bushing = 2517	
d3 = 107	Max bore = 60	
De = 120.86	r = 25	
Df = 128	S = 45	
Di = 100	Tooth number = 48	
Dp = 122.23	Type = 8M	